

x 1000 rpm	x 1500 rpm	Max. Contin. Pump Speed	Max. Intermit. Pump Speed	Max. Contin. Pressure	Max. Peak Pressure	Torque bar	Torque at 350 bar	Max. Flow	Weight without accessor.	Weight with accessor.	Max. Motor Temp.	Min. Motor Temp.
12,00 cc	18,00 cc	8000 rpm	8800 rpm	400 bar	450 bar	0.18 m.N/bar	66 m.N	96	6,00 kg	6,20 kg	-25°	110°

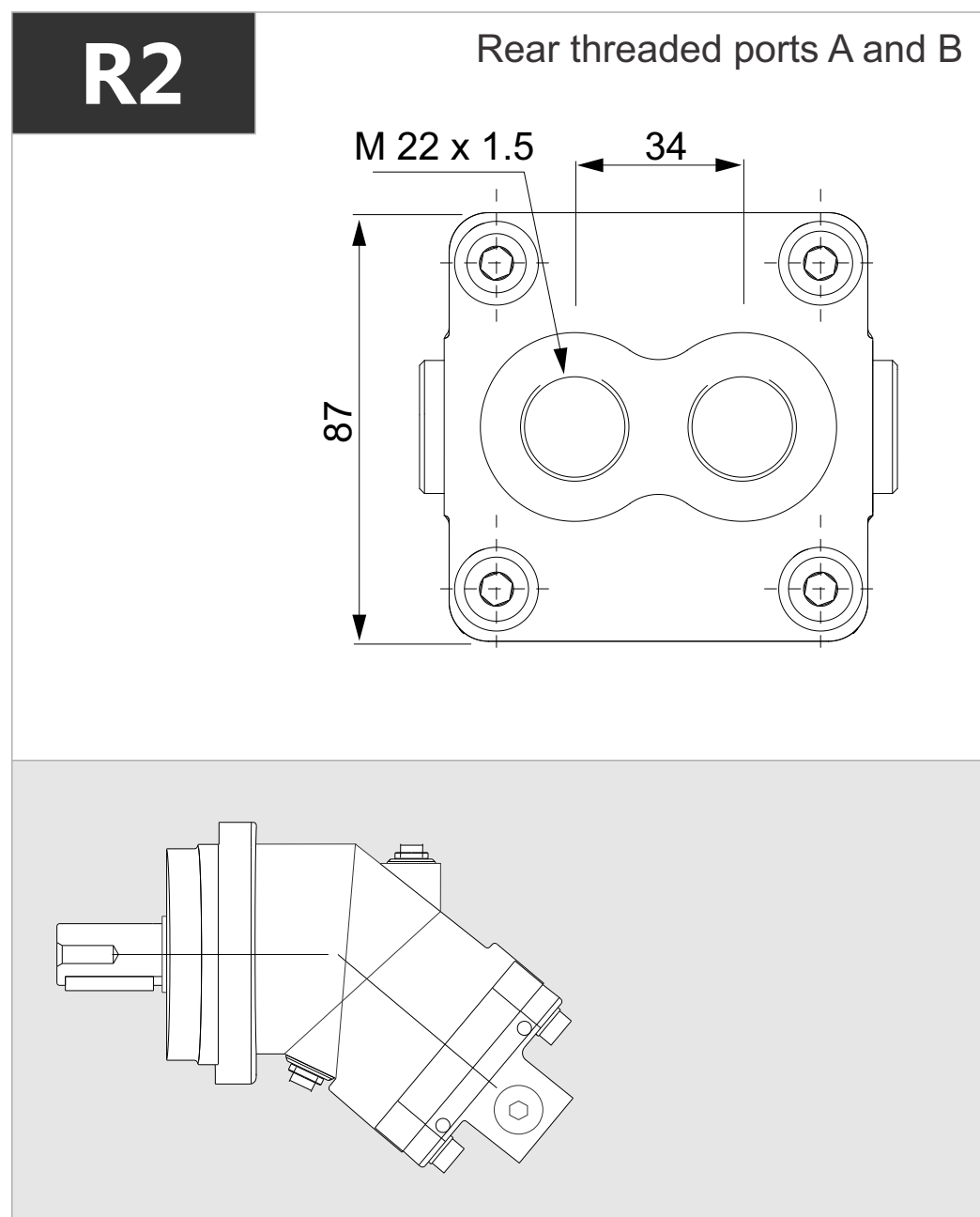
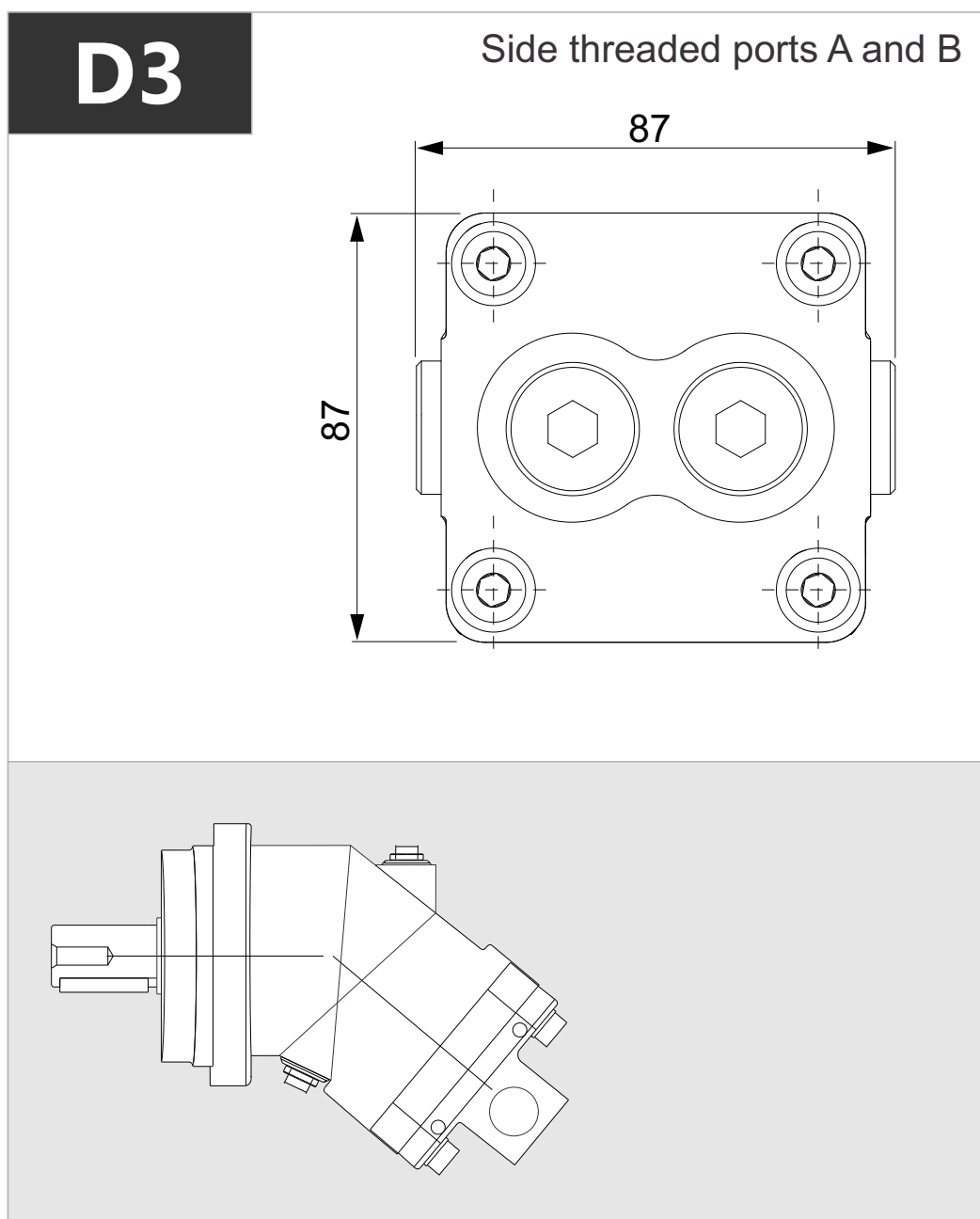
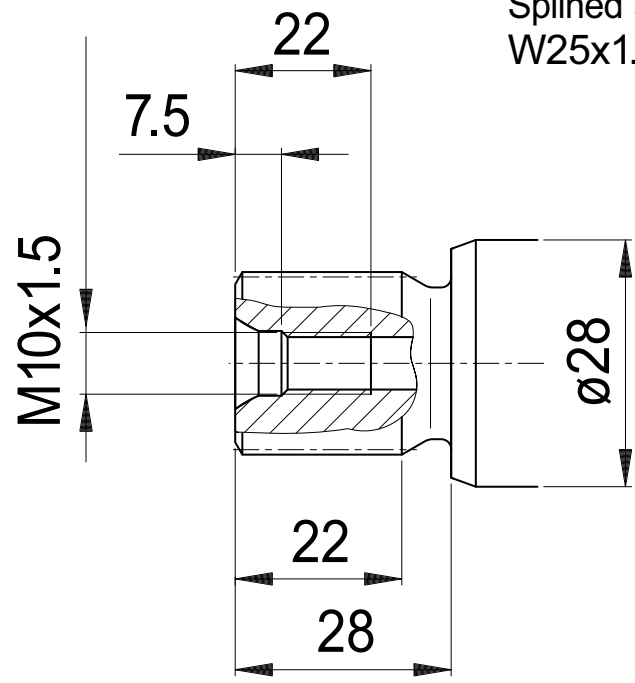
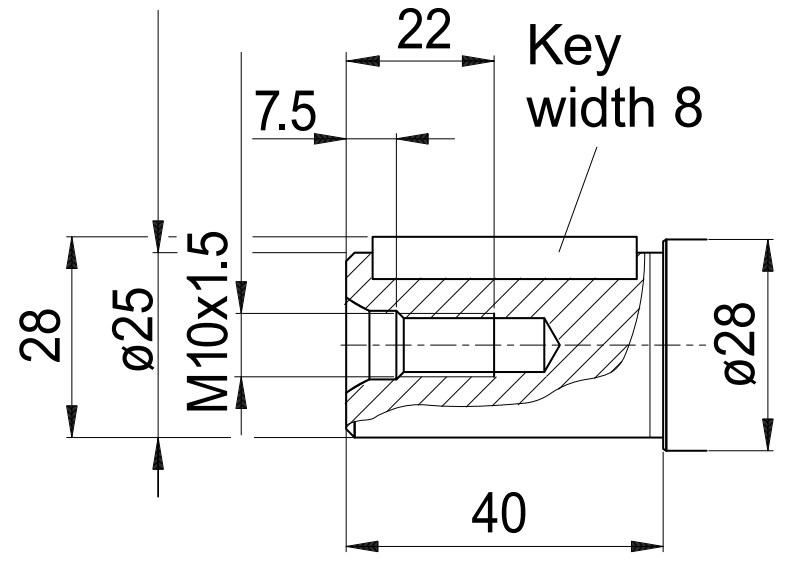

S1Splined shaft DIN 5480
W25x1.25x18x9g**K1**Parallel keyed shaft
DIN 6885, AS8x7x32**K2**Parallel keyed shaft
DIN 6885, AS6x6x32