

SAE B2 & B4 BOLT MOUNTING (SAE J744)

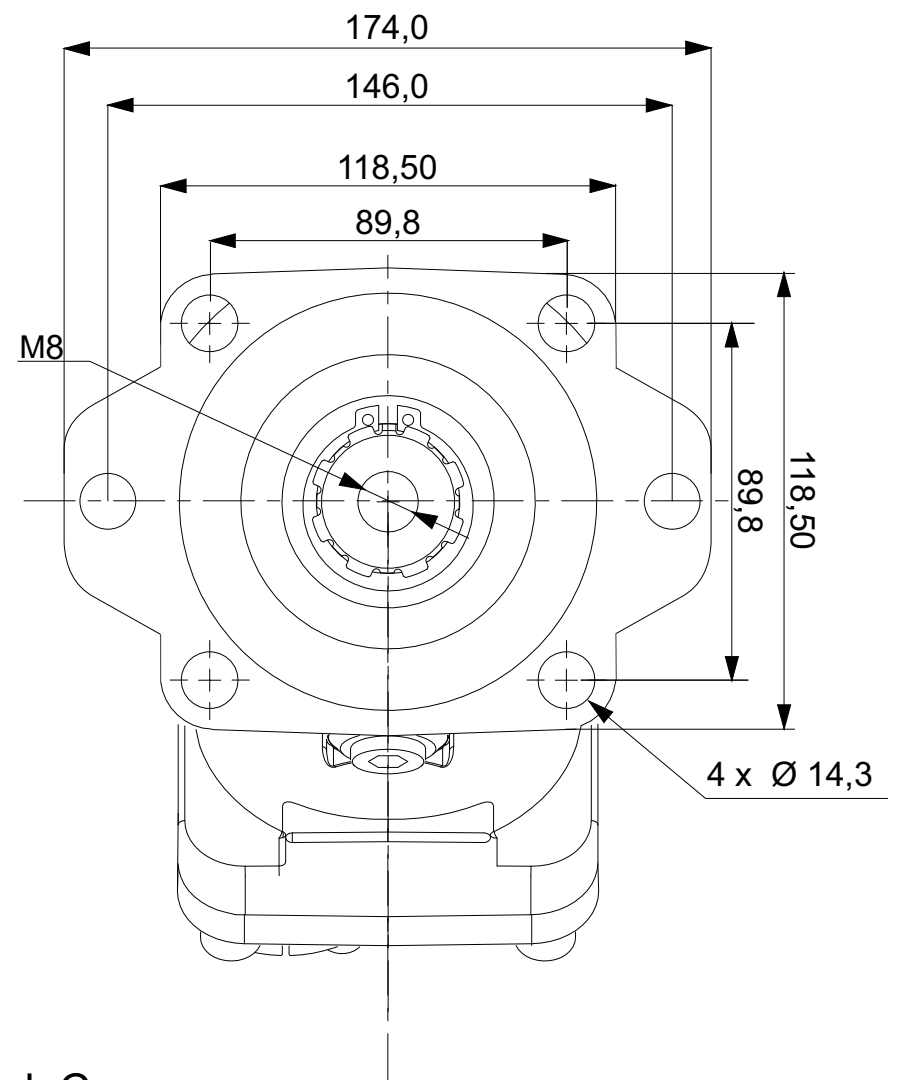

Spline Shaft

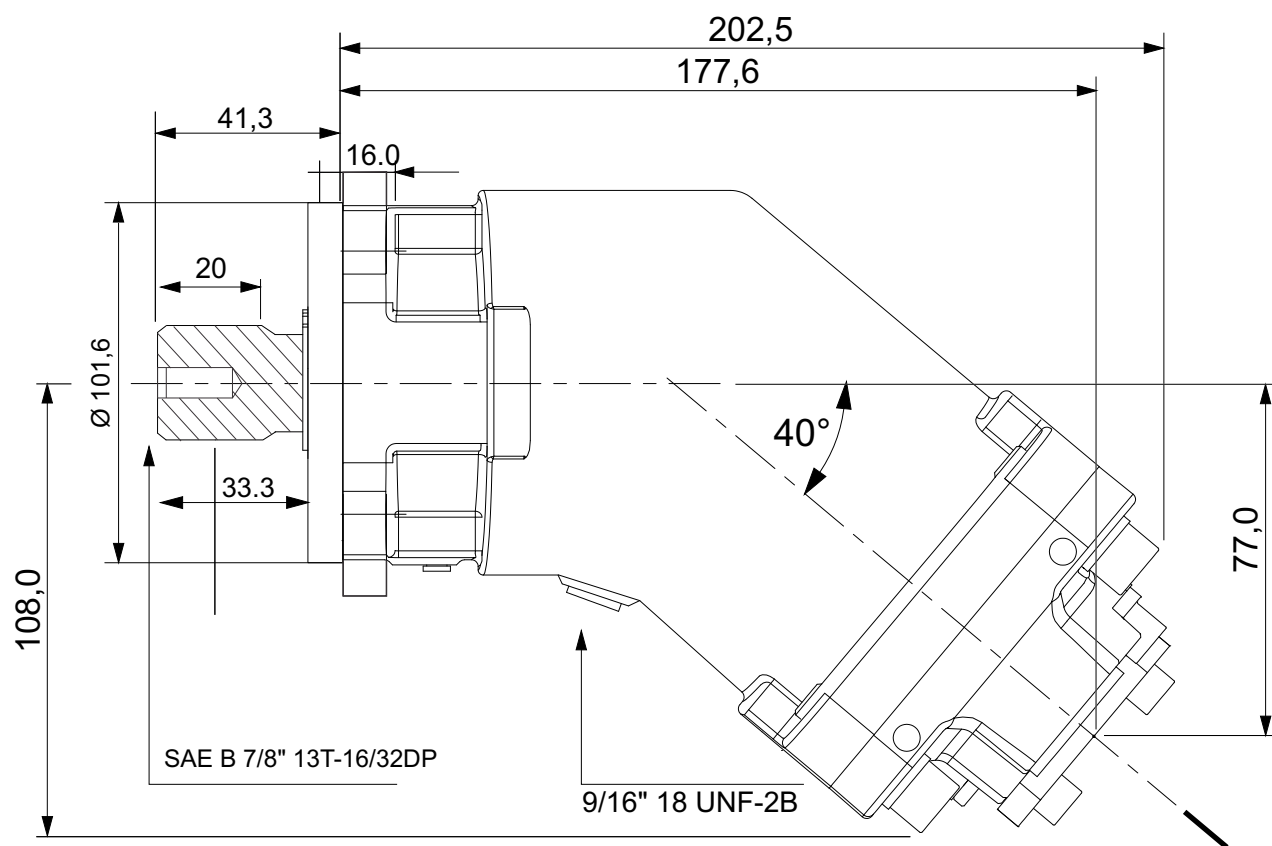
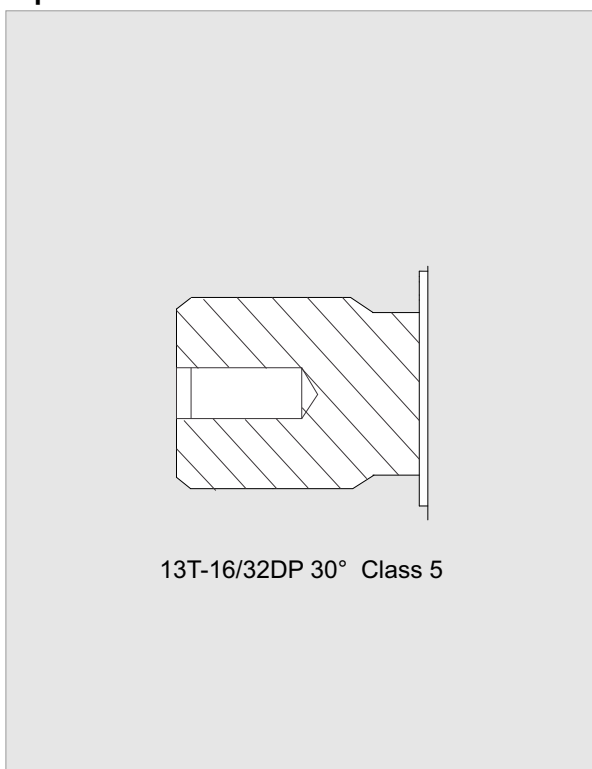

Keyed Shaft

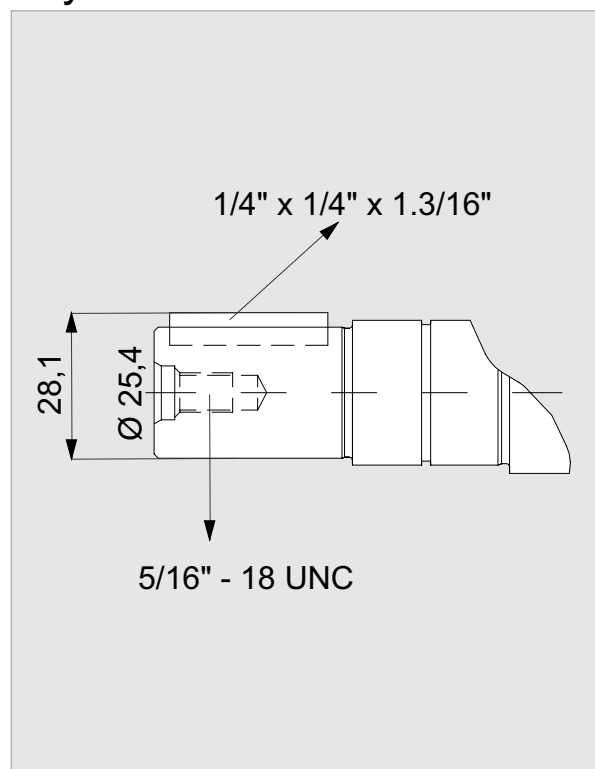

Back Cover

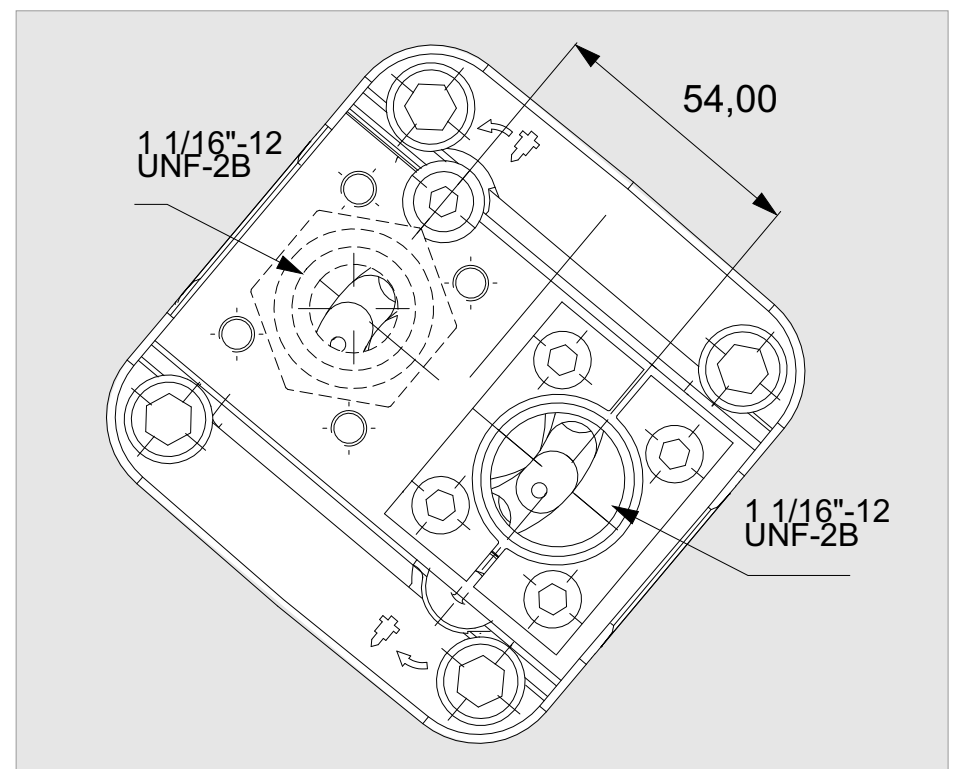

x 1000 rpm	40,20 cc
x 1500 rpm	60,30 cc
Max. Continuous Pump Speed	1900 rpm
Max. Limited Pump Speed	2500 rpm
Max. Continuous Pressure	350 bar
Max. Intermit. Peak Pressure	400 bar
Max. Torque at 350 bar	240 Nm
Weight without inlet fitting	11,50 kg
Weight with inlet fitting	11,90 kg
Rotation	CW-CCW

