

SAE B 7/8" 13T-16/32DP
SAE BB 1" 15T-16/32DP

SAE B2 & B4 BOLT MOUNTING (SAE J744)

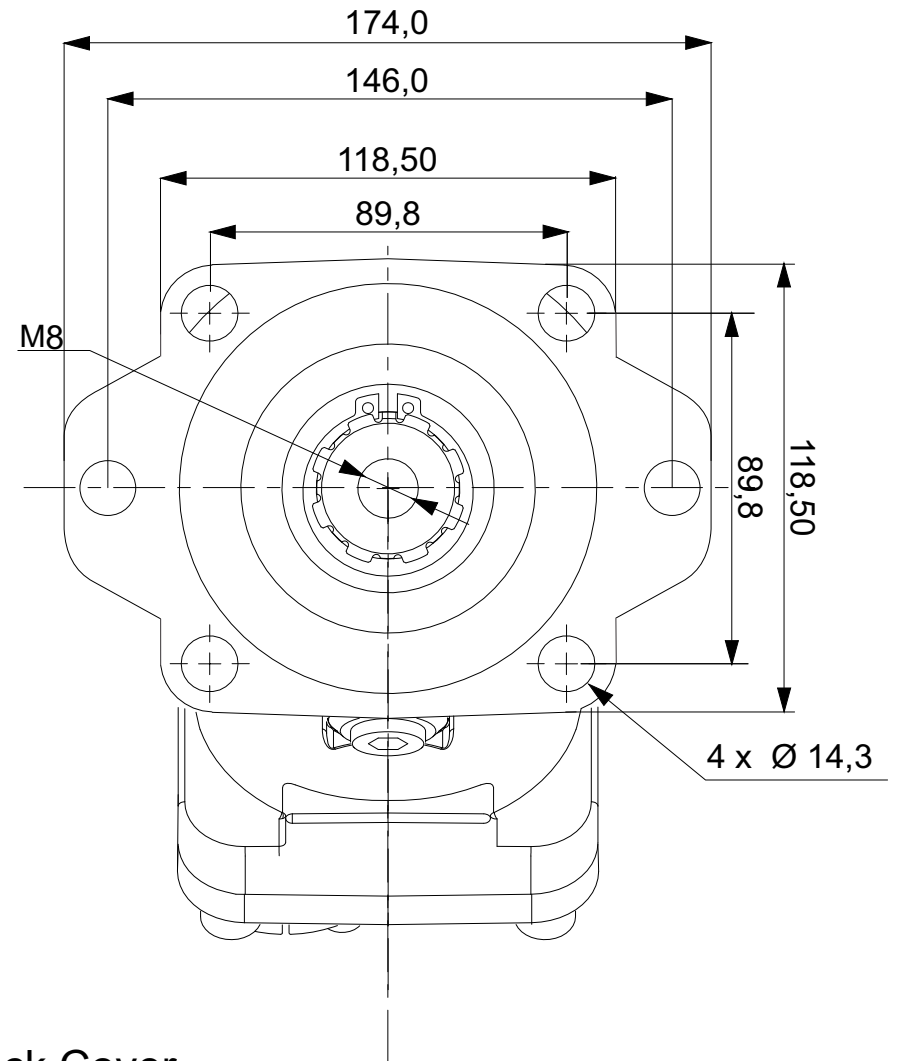

Spline Shaft

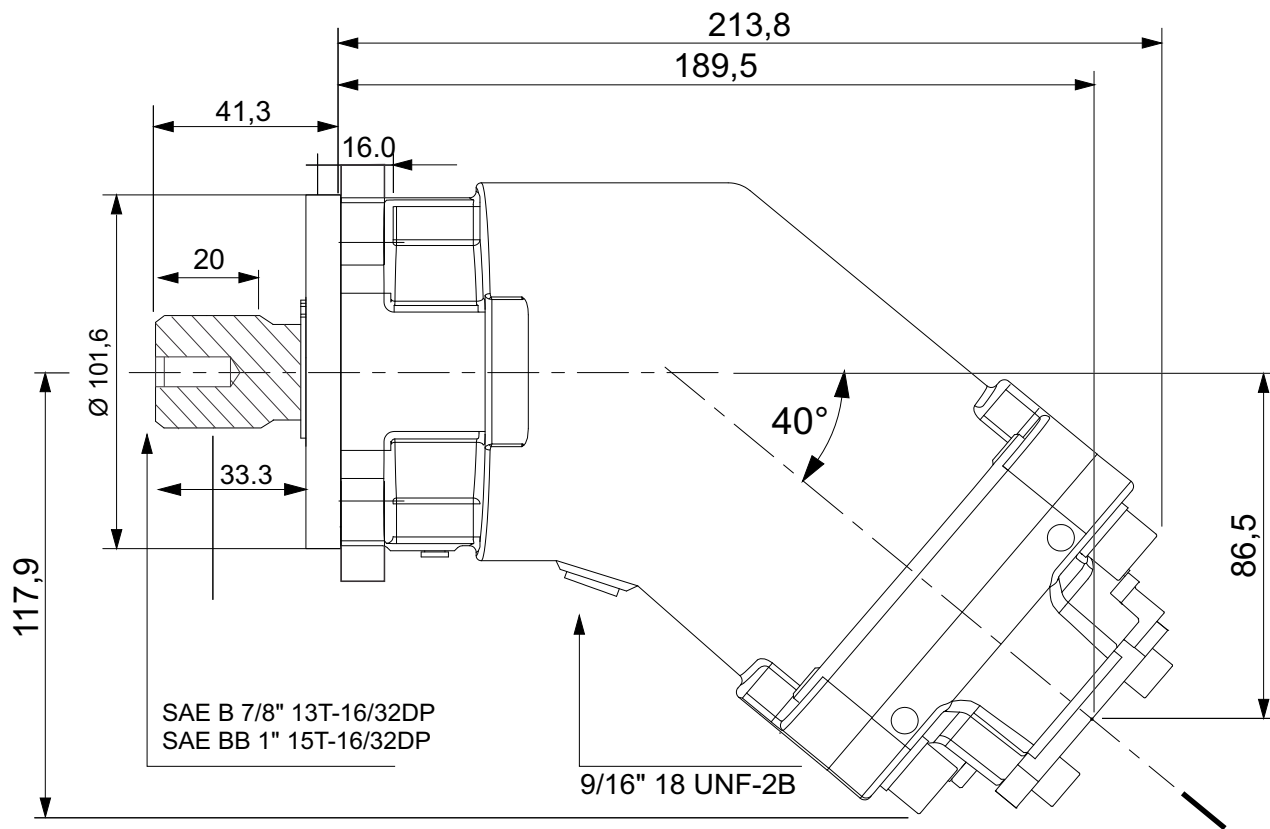

Keyed Shaft

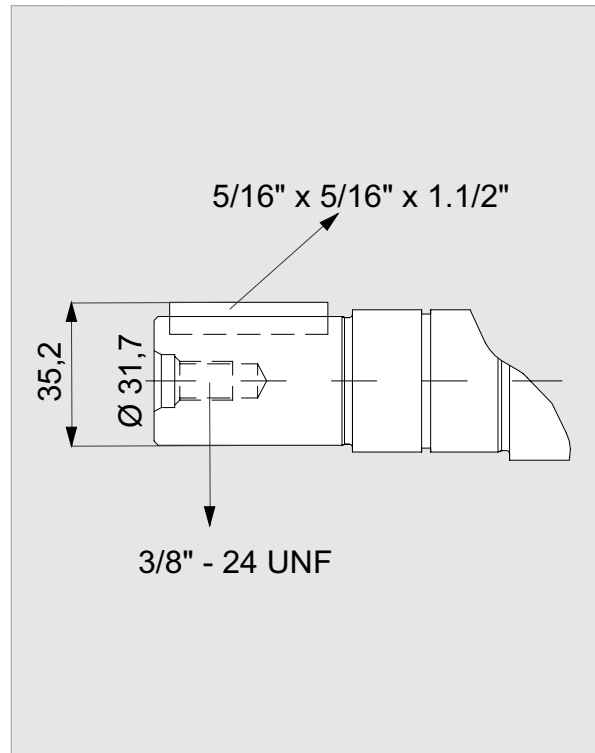

Back Cover

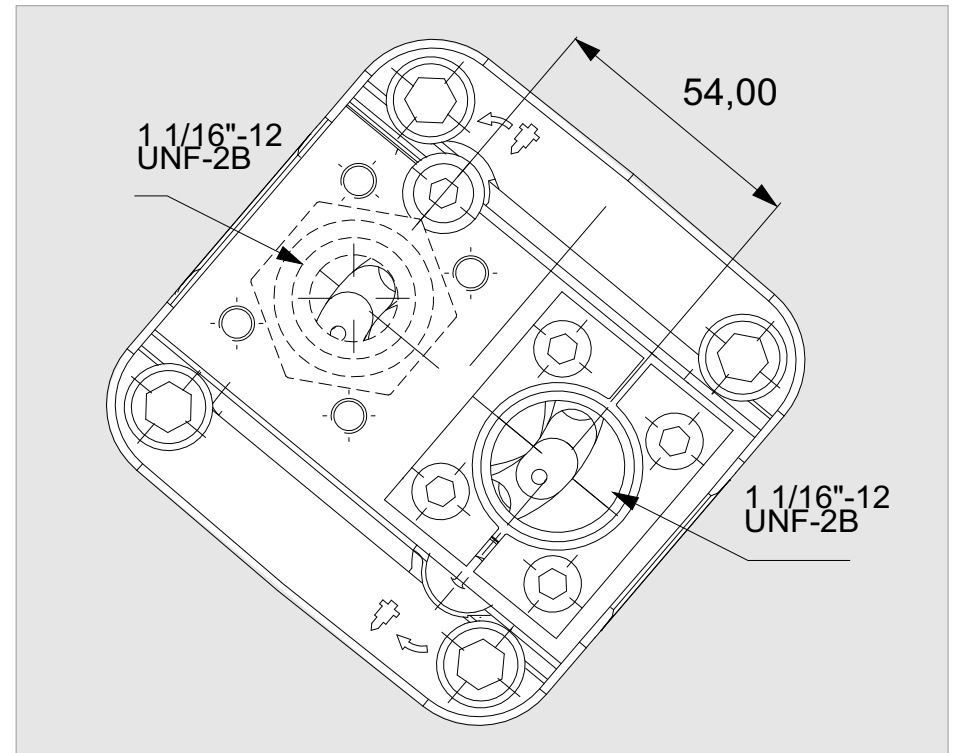

x 1000 rpm	56,40 cc
x 1500 rpm	84,60 cc
Max. Continuous Pump Speed	1900 rpm
Max. Limited Pump Speed	2300 rpm
Max. Continuous Pressure	350 bar
Max. Intermit. Peak Pressure	400 bar
Max. Torque at 350 bar	330 Nm
Weight without inlet fitting	12,50 kg
Weight with inlet fitting	12,90 kg
Rotation	CW-CCW

